

Tekniske tegninger

PVC, 3-lags glass, 80mm karmdybde



SPAREVINDUER

2-veis vindu, innoverslående

3-lags glass, 80mm karmdybde, PVC

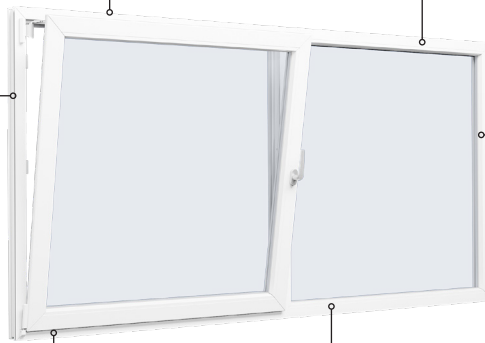
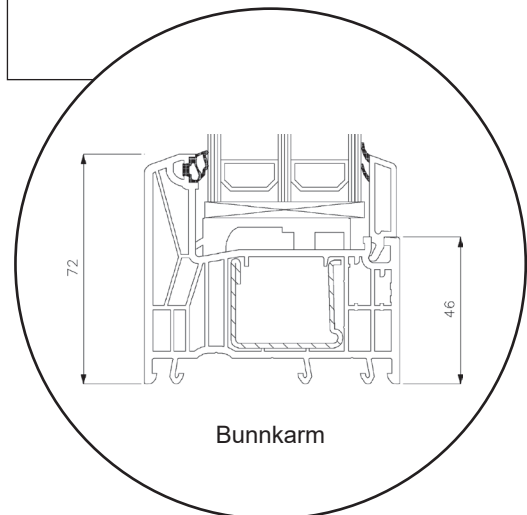
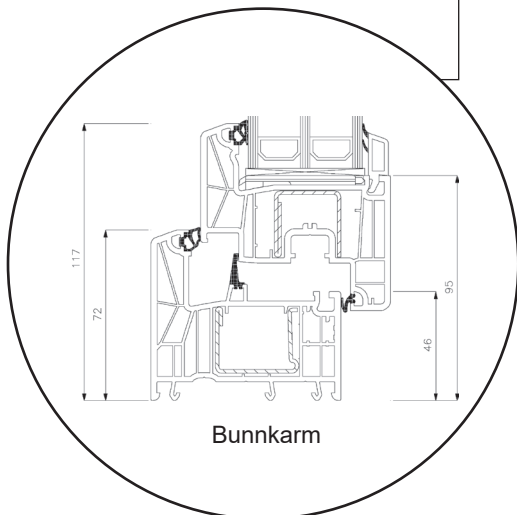
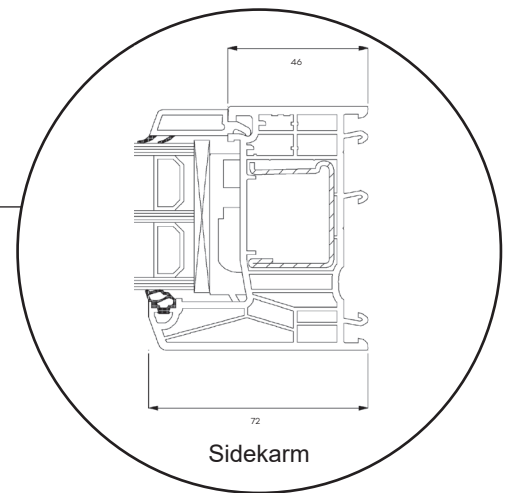
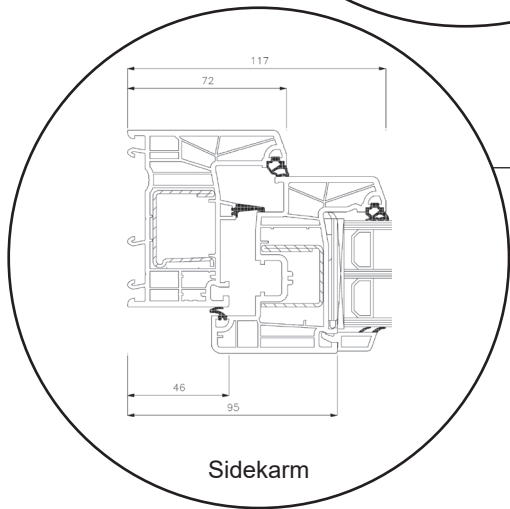
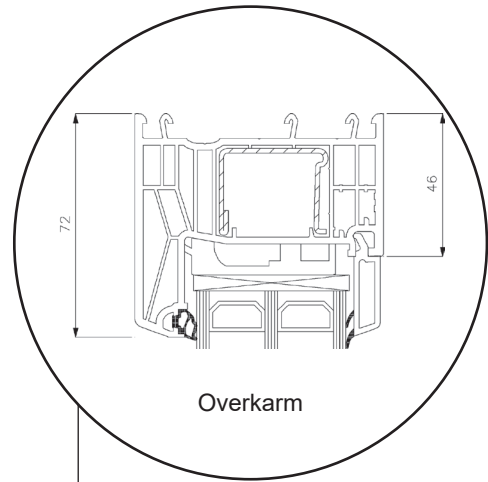
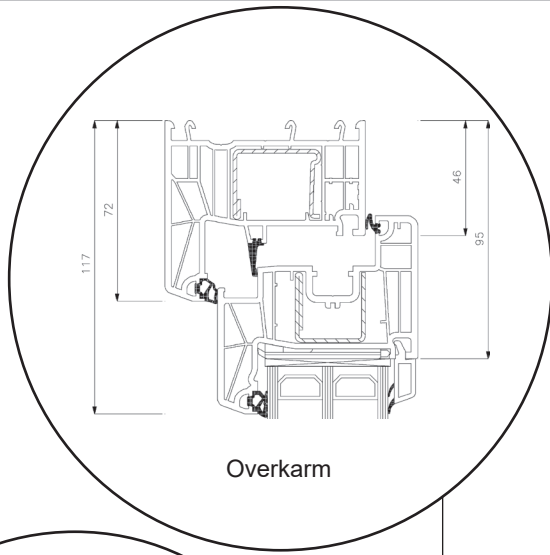

+47 66 90 03 03



post@sparevinduer.no

SPAREVINDUER

2-veis dør, innoverslående

3-lags glass, 80mm karmdybde, PVC

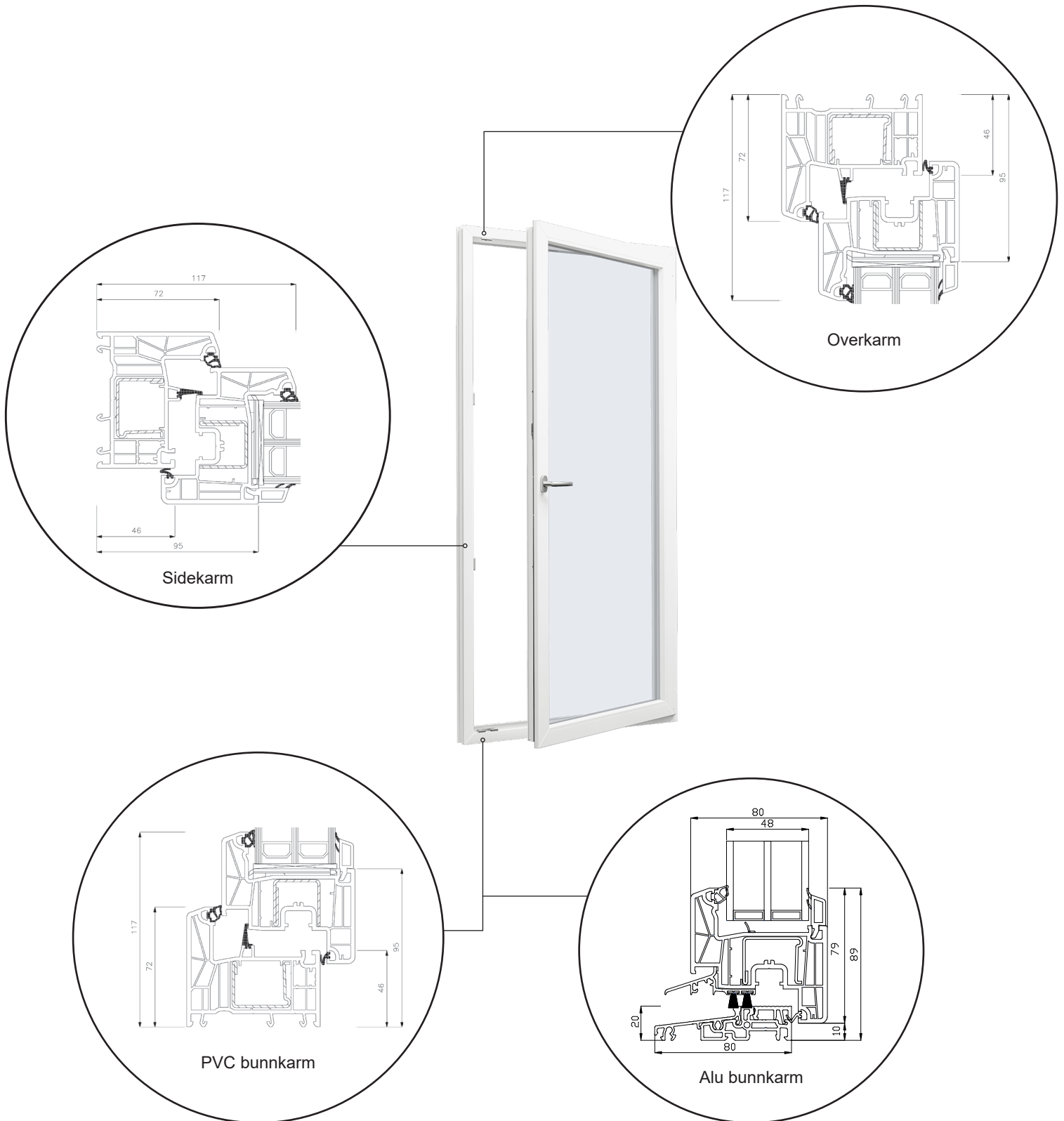

+47 66 90 03 03



post@sparevinduer.no

SPAREVINDUER